

ADA
AERONAUTICAL DEVELOPMENT AGENCY
(Ministry of Defence, Govt. of India)
P.B. No. 1718, Vimanapura Post, Bangalore-560 017, India.

Speed Post / Registered Post

248/ADA/SER/INT/IFCS

30 May 2018

REFURBISHMENT OF TD (IFCS) OFFICE AT I FLOOR
CANTEEN BLDG, ADA HQ COMPLEX

Quotation will be received up to 15:30 hrs on 02nd July 2018

Dear Sir (s),

1. Kindly arrange to submit your quotation with a covering letter within the time/date specified above. The quotation shall be forwarded in a SEALED ENVELOPE, super-scribing the name of the work, due date of quotation, full mailing address so as to reach the undersigned by post or by dropping in the Tender Box kept in ADA HQ reception Bldg.
2. The following documents are enclosed herewith:
 - (a) Annexure – I - Detailed Scope of Work.
 - (b) Annexure – II - General Terms and Conditions.
 - (c) Annexure – III - List of Drawing.
 - (d) Annexure – IV - List of approved Makes.
3. The site for execution of the work can be visited by the tenderer, if he so desires, to understand the work on any working days Monday to Friday between 09: 30 hrs to 16:00 hrs with prior intimation over phone.

Yours' truly,

(N Sermathi Pandian)
Addl Dir (Admin & Legal)



**REFURBISHMENT OF TD (IFCS) OFFICE AT 1 FLOOR
CANTEEN BLDG, ADA HQ COMPLEX**

Detailed Scope of Work

Sl No.	Description of work	Qty (approx)	Rate Rs.ps	Amount Rs.ps
(a)	(b)	(c)	(d)	(e)
1.	Providing and constructing Brick work using first quality table moulded bricks, in superstructure at first floor level in all shapes single brick wall or 9" thick wall using cement mortar 1:6 including racking the joints, scaffolding, curing, etc. complete, all as per instruction of ADA.	01.40 Cmt		
Rupees in Words:				
2.	Providing and laying in position manually mixed plain cement concrete(PCC) of ratio 1:2:4, 50 mm thick over the brick bat filler incl compacting, curing, etc. complete, all as per instruction of ADA.	0.15 Cmt		
Rupees in Words:				
3.	Providing and rendering cement mortar of 18 mm thick 1:4 ratio for internal, rough plaster. Internal surface shall be finished with Birla wall putty finished to line & level, smooth finishing incl scaffolding, curing etc. complete all as per the instruction of ADA.	17 Smt		
Rupees in Words:				
4.	Providing and fixing floor grade partly dark shade 1' x1' mat finish flooring tiles, 1 st quality of tiles, laid on 20 mm thick cement mortar 1:4, including pointing the joints with non shrink chemical with matching pigments etc. complete, all as per the OEMs specification. Make : _____	02.50 Smt		
Rupees in Words:				
5.	Providing and fixing wall grade light shade 2' x 1' glazed finish wall tiles, 1 st quality of tiles, laid on 20 mm thick cement mortar 1:4, including pointing the joints with non shrink chemical with matching pigments etc. complete, all as per the OEMs specification. Make : _____	11 Smt		
Rupees in Words:				



(a)	(b)	(c)	(d)	(e)
6.	Providing and fixing of Flush door shutter with frame of FRP size 1.8 x 0.75 m, incl door handle, aldrop & stopper etc. complete as per the instruction and sample available at ADA.	01 No		
	Rupees in Words:			
7.	Providing and fixing of 19mm dia CPVC pipe for water supply line. Water line for wash basin, W.C flushing cistern incl all specials, fixing the pipe with the clamps at 01 m spacing and these also includes jointing of pipes & fitting using solvent cement and cost of cutting chases and making the good the same, testing of joints etc. complete as per the instruction of ADA. Make : _____	20 Rmt		
	Rupees in Words:			
8.	Providing and fixing of PVC pipe 4 kg/sqcm for sanitary line, incl trenching, refilling, clamping on wall/floor etc. for outside manhole & internal waste pipe connecting to manhole including W.C pan, wash basin, rain water pipe vent with clamping, necessary specials etc. complete, as per instruction of ADA.			
a)	110 mm Dia. Make _____	10 Rmt		
b)	75 mm Dia. Make : _____	10 Rmt		
	Rupees in Words:			
9.	Providing and fixing white vitreous two piece EWC, P or S trap of size 660 x 365 x 770 mm, cistern seat cover, Twin flush fittings, flexible PVC connection pipe, incl C.P 2 way angle cock, health faucet ABS body(push type) with wall hook and 01 meter SS braided rubber hose pipe etc., all hardware complete, all as per the OEMs specification. Make : _____	01 Set		
	Rupees in Words:			
10.	Providing and fixing white vitreous wash basin of size 630x510mm incl pedestal, high neck pillar cock with aerator, C.P brass waste coupling, PVC waste water pipe with fitting etc. all hardware complete, as per the OEMs specification. Make : _____	01 Set		
	Rupees in Words:			
11.	Providing and fixing 05 mm thick mirror of size 1000 x 750 mm, fix to wall using SS studs, edges shall be machine polished etc, all hardware complete as per the OEMs specification. Make : _____	01 No		
	Rupees in Words:			



(a)	(b)	(c)	(d)	(e)
12.	Supply & fixing of heavy duty exhaust fan (300 mm sweep), incl Point wiring, switch control for Exhaust Fan with 2 runs of 650V grade 1.5 Sq.mm & 1 run of 1.5 Sq.mm FRLS insulated multi stranded copper wires, run in & incl 25mm dia, heavy gauge FR PVC conduits concealed in wall/ceiling conforming to IS 732, all accessories such as junction box, conduit bends, elbow and ceiling rose, anodized GI switch box with modular switch and box covered with front plate, etc complete all as per instructions of ADA. Make : _____	01 No		
Rupees in Words:				
13.	Supply & fixing of 12W LED surface mounted fixture, make Bajaj / WIPRO / Philips (BGCML 12 01 WW) incl. Point wiring, switch control for Light with 2 runs of 650V grade 1.5 Sq.mm & 1 run of 1.5 Sq.mm FRLS insulated multi stranded copper wires, run in & incl 25mm dia, heavy gauge FR PVC conduits concealed in wall/ceiling conforming to IS 732, all accessories such as junction box, conduit bends, elbow and ceiling rose, anodized GI switch box with modular switch and box covered with front plate, etc complete all as per instruction of ADA. Make : _____	02 Nos		
Rupees in Words:				
14.	Providing & fixing 10mm thick Shera fiber cement board, fixed over a GI C channel grid of 600mm C/ C with welding, to get line & level, even surface incl all necessary hardware , etc complete all as per instruction of ADA and OEMs specification.	06.50 Smt		
Rupees in Words:				
15.	Providing & fixing of 600 x 600 mm premium polished vitrified flooring tiles (light shade,) first quality of approved make (Code kerro 7000,7001,7002,6021,6023 & equivalent) laid on the existing mosaic floor, fixed using suitable adhesive(Dry construction), fixed to true line & level with / without spacer joints filled with suitable non shrink filler chemicals, incl surface preparation such as filling pot holes, cracks , crevice, etc, complete all as per sample available at ADA and OEMs specification. Make : _____	65 Smt		
Rupees in Words:				



(a)	(b)	(c)	(d)	(e)
16.	<p>Providing, fabricating & fixing of wooden storage units of assorted size wall mounted or free standing units of depth 450 mm, made out 19mm thick block boards of Termite / Water proof grade for all Vertical / Horizontal members including back. All External surface shall be finished with 01 mm thick & Internal surface shall be finished with 0.80 mm thick approved shade of laminate, standard hardware's such as lock, C type PC handles, piano hinges, ball catch. All exposed edges shall be finished using PVC beading etc., complete neat and attractive finish, all as per samples available at ADA.</p> <p>Make : _____</p>	19 Smt		
Rupees in Words:				
17.	<p>Providing & fixing in position mineral fiber acoustic ceiling tiles of size 600 x 600 mm x 15 mm over the existing formed grid after removing of defective tiles (VUNUS III pattern of tegular edge). The board shall be fire rating of 60 minutes as per BG 47g/23 of 1987, light reflection above 85%, noise reduction coefficient (NRC) of 0.55 to 0.66 sound tenuation of 32 db and humidity resistance upto 95% at 50c including making Provision / opening and strengthening for light fitting, A/C diffuser etc., complete all as per the instruction of ADA and OEMs specification.</p> <p>Make : _____</p>	65 Smt		
Rupees in Words:				
18.	<p>Providing, fabricating & fixing of linear type modular work station of size 1000 x 600 x 790 mm 03 nos combined, table top made out of 25 mm thick PLB and under structure made out as of 19 mm thick PLB finished with PVC edging, key board tray, wire manager, CPU trolley, pedestal etc. complete all as per the OEMs specification. The main beam of the modular partition shall not be less than 60 mm, 2 levels of cable race way (date / power), height adjustable knob to take care of undulation, the stability of the structure individually and total shall be responsibility of the vendor.</p> <p>Make : _____</p>	01 Set		
Rupees in Words:				



(a)	(b)	(c)	(d)	(e)
19.	Providing & fixing glass writing board made out of 12mm frost glass of size 1200 X 900 X 12 mm fixed with SS bush incl necessary hardware, etc. complete. As per sample available at ADA. Make : _____	01 Job		
Rupees in Words:				
20.	Providing, fabrication and installation of manually operated Roller Blinds, Translucent lighter shade fabric incl accessories size approx: 1100 X 1500 mm X 03 Nos, 800 X 1500 mm X 01 No & 2200 X 1500 mm X 03 Nos. [total 07 nos]. The roller blinds shall be controlled by Chain Drive, all as per OEMs specification. The rate quoted for this item of work shall be inclusive of fabric, roller pipe, brackets, head rail etc., complete. Actual area of Roller Blinds fixed to each windows shall be considered for measurement. All as per sample available at ADA. Make : _____	17 Smt		
Rupees in Words:				
21.	Providing & rendering Royal Emulsion distemper of mushroom/ white/lighter shade colour on wall over a coat of wall primer , two or more coat to get even and neat finish, incl touch up putty, roller finish, etc. complete all as per sample available at ADA and OEMs specification. Make : _____	30 Smt		
Rupees in Words:				
22.	Providing & rendering re-polishing of existing wooden partition and doors, single coat to get neat and even finish using spray machine similar to existing matt finish surface incl cleaning the glass, etc. complete all as per sample available at ADA(MRF PUF coating) and OEMs specification.	45 Smt		
Rupees in Words:				
23.	Providing alteration to existing teak wood shutter incl frame, locking arrangement, reorientation as per room utilization etc, incl material and labour complete all as per instruction of ADA.	03 Nos		
Rupees in Words:				
24.	Total			



(a)	(b)	(c)	(d)	(e)
25.	Less towards dismantling of existing teak wood full height partition of size (3.6 m x 2.4 m) partly panel & partly glazed incl of cable raceway, glass, teak wood beading, buy back of the same etc. all as is where condition.	09 Smt		
	Rupees in Words:			
26.	Total			
27.	GST _____ %			
28.	Grand total			
	Rupees in Words :			

Note : The make of the material proposed to be used for which the rate is quoted should be indicated against the items where **make is asked**.

Seal & Signature of the Contractor:

Date:



REFURBISHMENT OF TD (IFCS) OFFICE AT I FLOOR
CANTEEN BLDG, ADA HQ COMPLEX

General Terms & Conditions

1. This is an item rate contract based on scope of work, schedule of items, specifications, BOQ, drawings and site conditions. Payment will be released on completion and handing over of the entire work based on actual measurement at site.
2. The Sealed Envelope containing the quotation shall be **super-scribed** with the Name of the Work, date and full address of the firm.
- 3.1 **Security:** The entire work has to be carried out in restricted area / Offices in a batched manner with least disturbance to officials / equipments. Adequate manpower shall be provisioned / deployed for the above work. Also, the work has to be carried out with ut-most care as live Electrical / Data / Voice cables are already laid and are in working condition. The work has to be carried out between 09:00 hrs to 18:00 hrs. Work Permit will NOT be given on ADA Holidays / Sundays.
- 3.2 Necessary Security formalities should be completed before commencement of the work. Particulars of Supervisor/labours being deployed to be filled up in the format provided by the ADA security authorities duly signed by the contractor and countersigned by the ADA authorities to be submitted. Police verification for Supervisor/Proprietor may be submitted before commencement of work.
- 3.3 You shall ensure that NO personnel of doubtful character/antecedents will be employed. The contractor shall follow all the security norms of ADA and willing to accept the security checks by the security personnel of ADA. The contractor shall ensure that the contractor's workmen shall not enter any other places and should restrict themselves to the work area only. If any person employed by you found alcoholic while working, ADA shall reserve the right of asking the contractor to expel the person from the work spot and deny entry due to security reasons. The contractor shall carry out the said work at ADA premises for which he shall provide all tools, tackles, equipment's waste, etc., and any other items required for executing the work. He shall also be responsible for the safe custody of his belonging/stores while working in ADA. Materials brought to site for incorporation into the work shall accompany with delivery note and shall be entered in the MATERIAL INWARD Register at the gate. The excess materials if nay taken out of ADA should be with proper gate pass.
- 3.4 The contractor or his authorised representative with sufficient experience shall be available at the site throughout the period of execution of the work to supervise the work and receiving instructions from the department from time to time.
- 3.5 All the work done by the contractor under the contract would be liable for inspection by the co-ordinator for the work to ensure that the works are in general being executed according to the design, drawings and specifications laid down in the contract.
- 3.6 All materials to be used on the work will have to be got approved by the co-ordinator before use and the same should be as per the make, quality and specification as per the bill of quantities (BOQ).



3.7 NO omission in the drawings, bill of quantities or specifications shall absolve or relieve the contractor of his responsibility to ascertain the requirements and provide the required expertise, labour and materials to attain best standards of workmanship, ergonomics and aesthetic appearance.

4. **Representative at site:** You shall, during the progress of work employ qualified, experienced and competent supervisor at site for executing the said work. Any decision, instruction, authorisation of approval given by ADA to such contractor's supervisor shall be deemed to have been given to the contractor.

5. **Accident/injury to workmen:** The contractor shall be solely liable for accident/injury that may happen to any of the personnel engaged by him or his sub contractor in connection with the contract work. ADA shall not be liable for any damage or compensations in respect of or in consequence of any accident or injury to any personnel in the employment of the contractor or his sub contractor and the contractor shall indemnify ADA from compensation and proceedings. The contractor or his sub contractor shall forthwith report to ADA all cases of accident to any of their personal/workmen and shall make every arrangement to render all possible assistance and aid to the victim of the accident.

6. **Guarantee :** The entire work, after completion / handing over shall be **guaranteed** for a period of **One (01) year**.

7.1. The entire work has to be completed within **Eight (08) Weeks** and as specified in the order.

7.2 Electricity & water will be issued free subject to its availability. Contractor has to make his own arrangements to avail the same at his risk and subject to satisfying statutory rules and regulations, if any.

8. The vendor shall quote both in figures and in words against each item of work and arrive at Total Amount of quotation. The vendor shall include in his quotation any / all miscellaneous works / items which are not specifically mentioned, but without which the work cannot be completed in all respect (viz breaking, chipping, making openings, patch up, making good the same, etc.)

9. Timely execution is essential condition of the contract. Default shall invite, at the discretion of ADA, cancellation of the order in part or in full and / levy of liquidated damages at the rate of 0.5% of the total price of the contract for every week of default or part thereof, subject to a maximum of 05%.

10. The submission of a tender by the tenderer implies that he has read all the terms and conditions and made himself aware of the scope of work, specification, local conditions and other factors bearing on the execution of the work. Therefore, you are requested to visit the site and get acquainted with the site conditions before quoting. The work shall be carried out strictly in accordance with National Code of Practices and relevant IS codes.

11. **Terms of Payment:** Up to 95% of the completed cost of work shall be released upon completion and handing over of entire work through e-payment. Bill can be submitted after completion and handing over of entire work. Payment will be cleared within 30 days from the date of submission of bills.



12. 05% of the completed value of contract shall be retained as Retention Money for a period of **ONE (01)** year towards defect liability (interest free). The retention money shall be released against bank guarantee submitted towards guarantee for the work for one year.

13.1 The quantities and items of work shown against each items of BOQ are indicative and NOT binding. The quantities mentioned in BOQ may or may NOT vary. Since this is an Item rate contract, the vendor shall complete the work as per the drawings, specifications, and to the entire satisfaction of ADA. Measurements will be taken during the progress of work and on completion. Payment will be made as per actual quantity executed at site.

13.2 All the debris, rubbish, waste materials etc., should be cleared off the site on completion of the work. As already the office is functioning in the building and hence least disturbance to the staff working there should be made and the area should be cleared and kept tidy after the days work.

13.3 All measurements will be recorded in a measurement book during progress of the work and the bill will be prepared based on the actual measurements at site. The measurement book duly certified by the co-ordinator will be submitted with the bill.

13.4 Income tax as applicable will be recovered from the payment and necessary certificate will be issued by Finance Dept.

13.5 The contractor has to furnish his bank account details and other e-payment details on award of the work, so that payment can be made through ECS/EFT.

14. You are requested to submit your offer in the enclosed format only. Also return all the tender documents and drawings along with your offer duly signed on all pages.

15. **If you are not interested for this work, all the documents forwarded herewith should be returned to this office for records with the words "Blank Tender" prominently written on the cover itself. Please state reasons for submitting a Blank Tender under a separate letter.**

16. Quotations shall be valid for at least 45 days from the due date for submission of the same.

17. ADA reserves the right to accept or reject any quotation without assigning any reason.

18.1. GST which is legally leviable and intended to be claimed should be distinctly shown separately in the quotation. Otherwise, it will be deemed to be treated as, price quoted by the vendor is all inclusive. ADA cannot provide C/D forms, concessions / exemptions of GST. Input taxes will be included in the rate quoted and the taxes actually paid by the vendor will be reimbursed on production of proof of its remittance. The applicability of GST for Govt civil works may be ascertained before quoting the taxes applicable.

18.2 Contractors should provide their GSTN, HSN code, the place of their registration and copy of registration certificate along with the tender.

18.3 The contractor should provide details of their registration with Govt departments, experience in similar works and copies of similar works executed by to them during the past two years.

18.4 Canvassing in any way for award of the work or workmanship is strictly prohibited and tenders of tenderers who canvass in any form will be liable for rejection.



18.5 The successful bidder shall not sub-contract, transfer or assign the work to any other agency by means of "Power of Attorney" or any other form without the prior consent of the Dir (Admin & HR), ADA.

19. **Additional Requirements :** Any additional requirement necessitated during the course or work, which is not in the scope of work and being an essential requirement for completion of the work, shall be projected separately while quoting the rates. The probable vendors may visit the site and take stock of the works to be executed before submission of the tender.

20. If any differences of opinion or dispute would arise between ADA and the Contractor in connection with the implementation of this work, both shall mutually discuss to arrive at an amicable solution. Failing an amicable solution, dispute arising in this connection shall be finally settled under Arbitration and conciliation Act 1996. The proceedings would be conducted in Bangalore by an Arbitration of three arbitrators one each from the respective parties and one by mutual consent to be appointed by the respective parties and one by mutual consent to be appointed by the respective and the award pronounced by the said Arbitrators would not be open to challenge and is final. Disputes if any, arising out of this contract shall be settled under the Arbitration and Conciliations Act 1996, as amended from time to time.

- X - X - X - X - X -



**PROVISION OF REFURBISHMENT OF TD (IFCS) OFFICE AT
I FLOOR CANTEEN BLDG, ADA HQ COMPLEX**





LIST OF DRAWINGS

Sl No.	Name of the Drawing	No of Pages
1.	Plan of Existing rooms of TD IFCS(Drawing No. 1)	1
2.	Plan of TD IFCS office(Drawing No. 2)	1
3.	Plan of Room No CF-03 IFCS(Drawing No.3)	1
4.	Plan of Wash Room (Drawing No. 4)	1
5.	Elevation of Wooden Storage (Drawing No. 5)	1

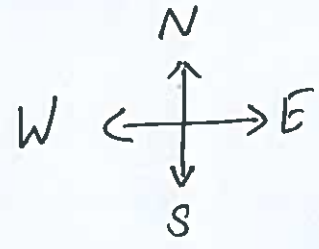
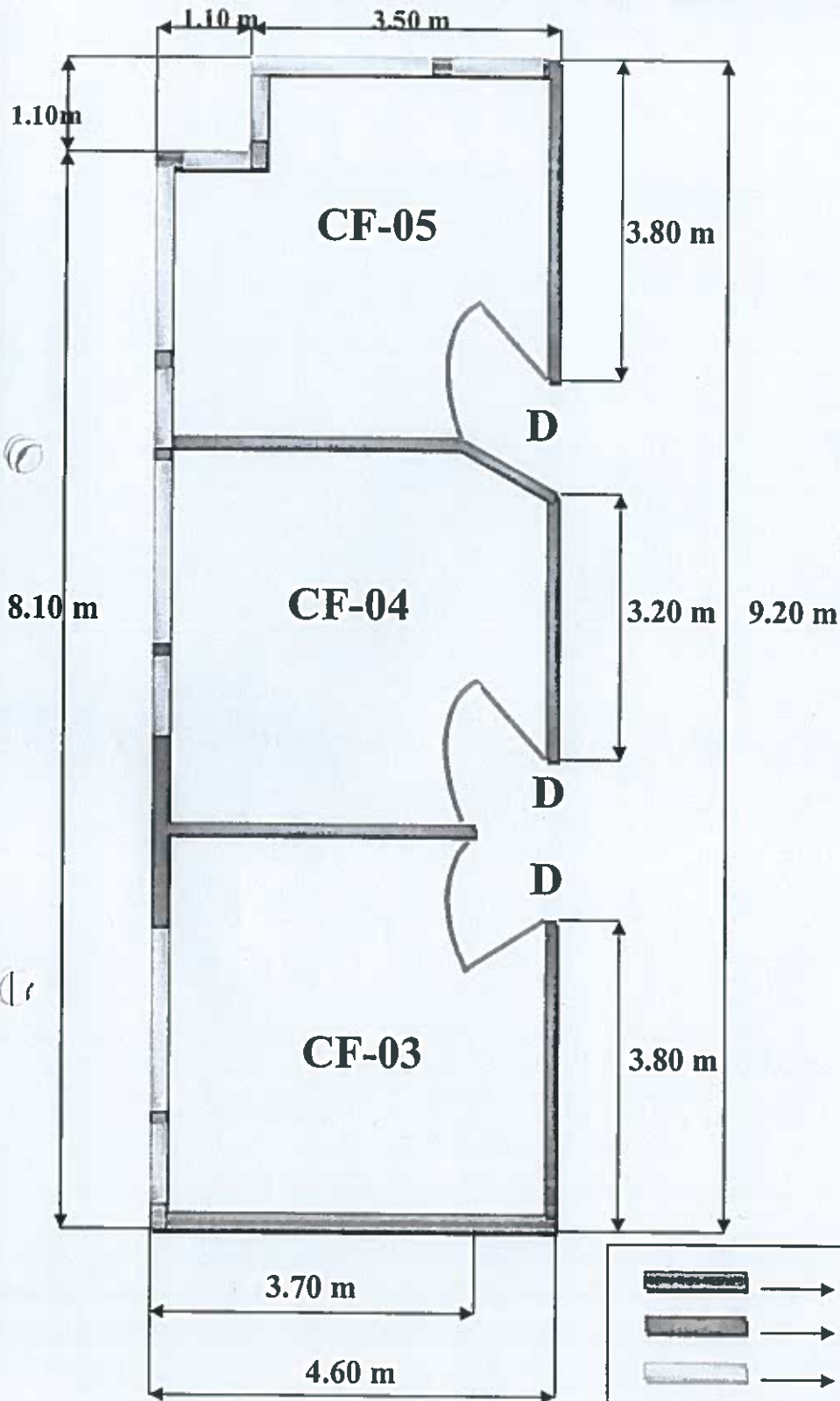

EXISTING TD IFCS ROOM



-  → Brick Wall
-  → Wooden Partition
-  → Window (size 2.2 m x 1.5 m)
-  → Window (size 1.1 m x 1.5 m)
-  → Window (size 0.8 m x 1.5 m)
- D** → Door (size 1 m x 2.1 m)



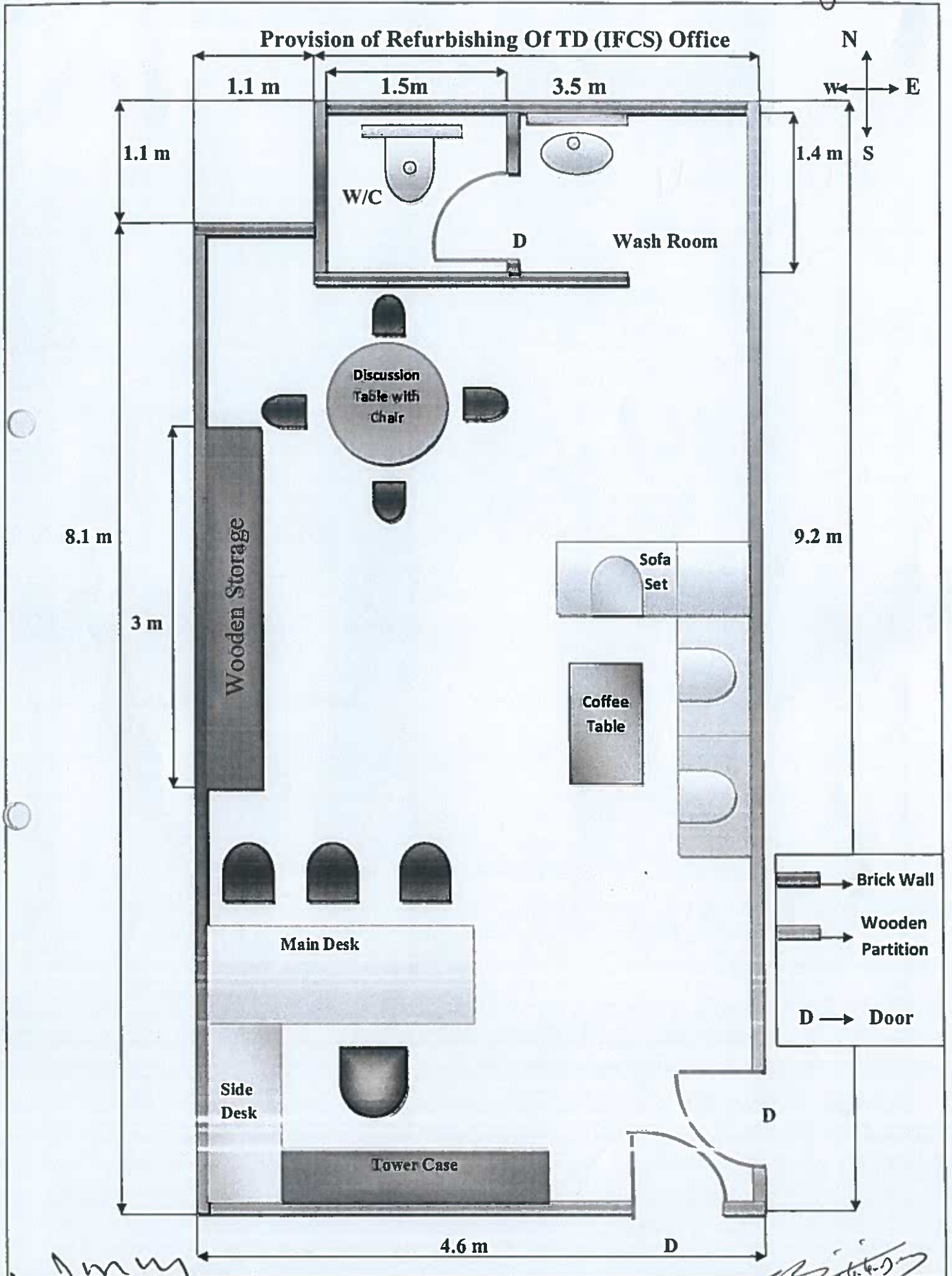

K. T. MANI MARAN
Sr. ADMIN OFFICER-II

USER TD (IFCS)

Provision of Refurbishing of CF-03 IFCS

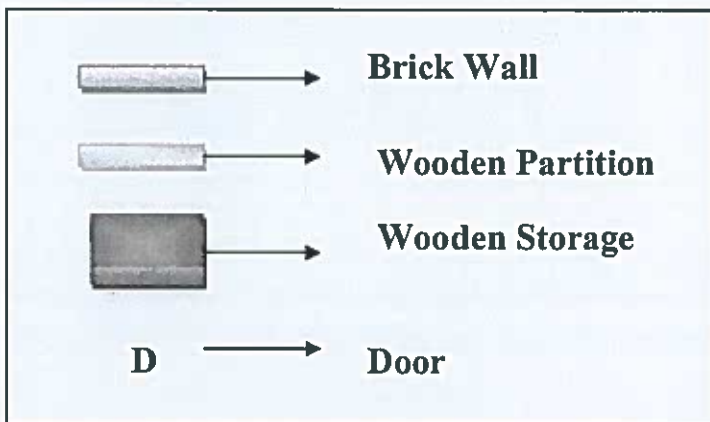
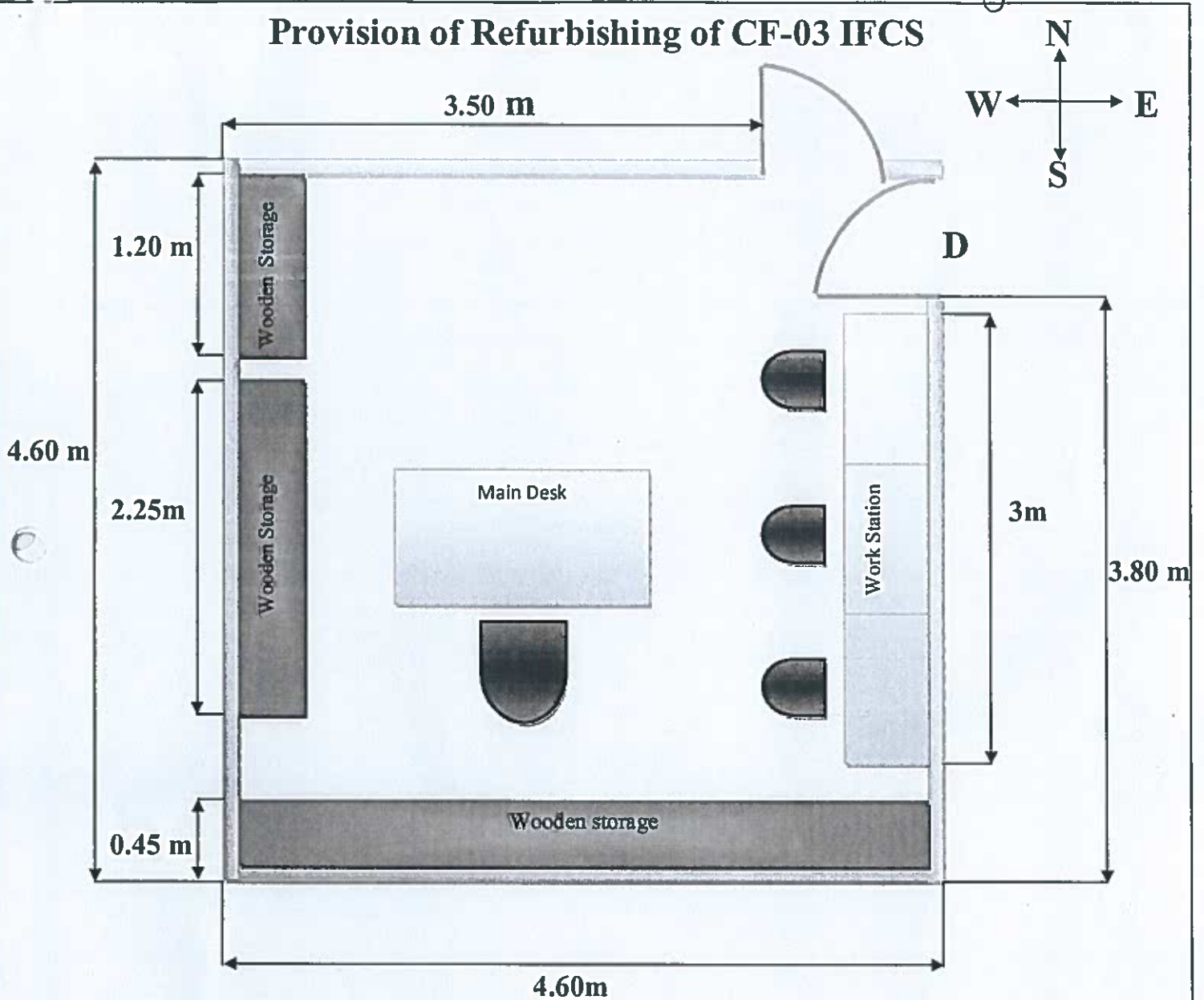

PROVISION OF WASH ROOM FOR TD IFCS

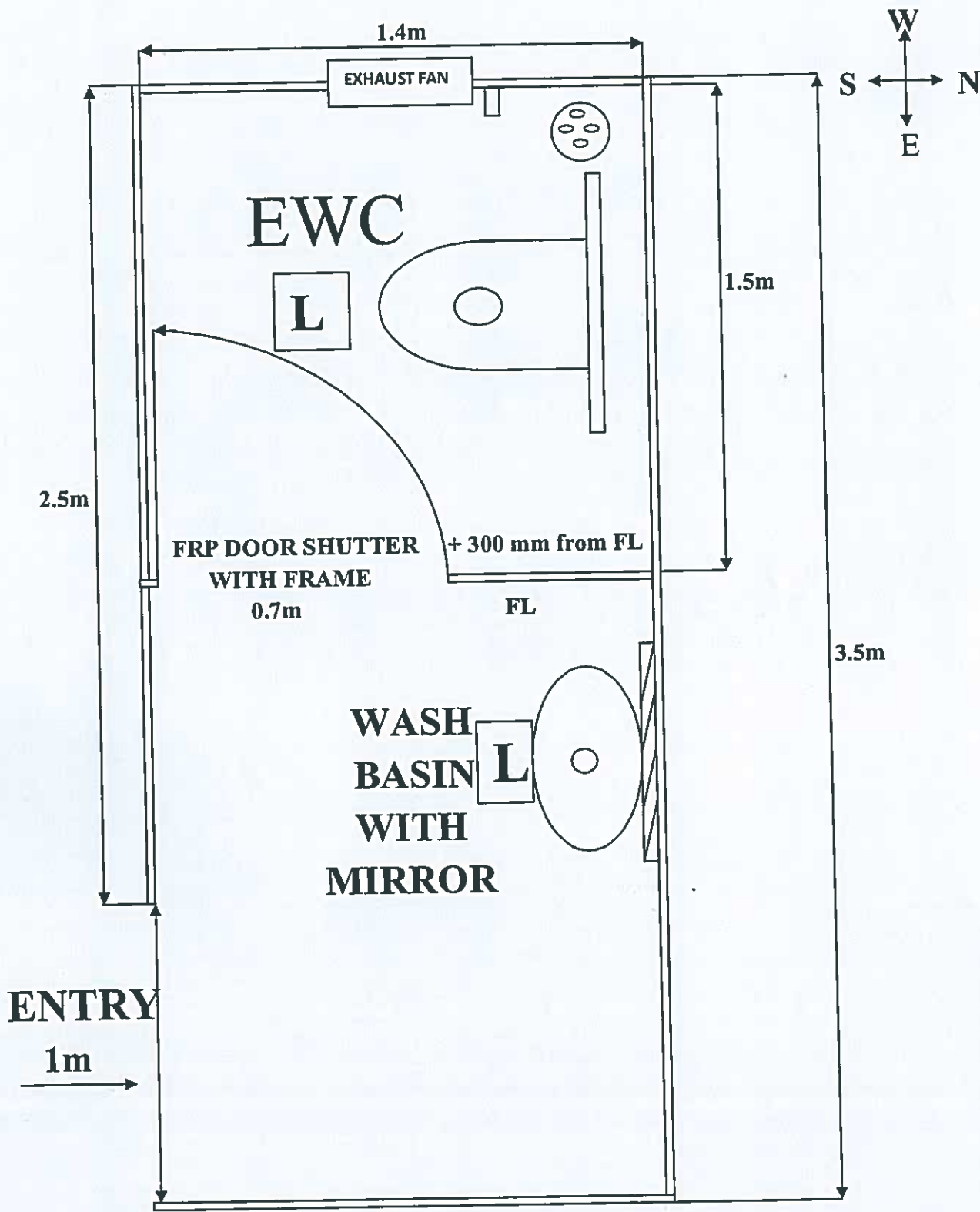

WOODEN STORAGE UNIT SIZES

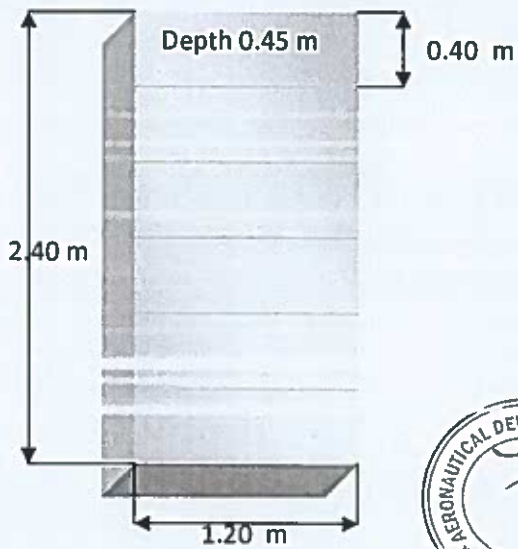
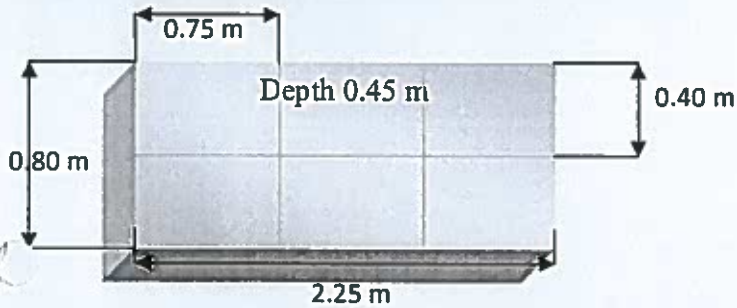
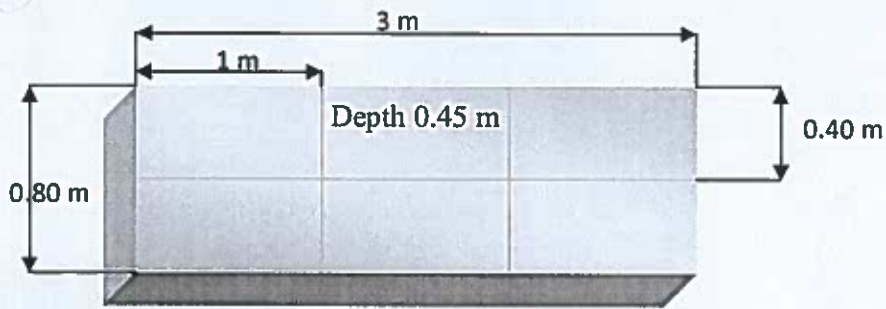
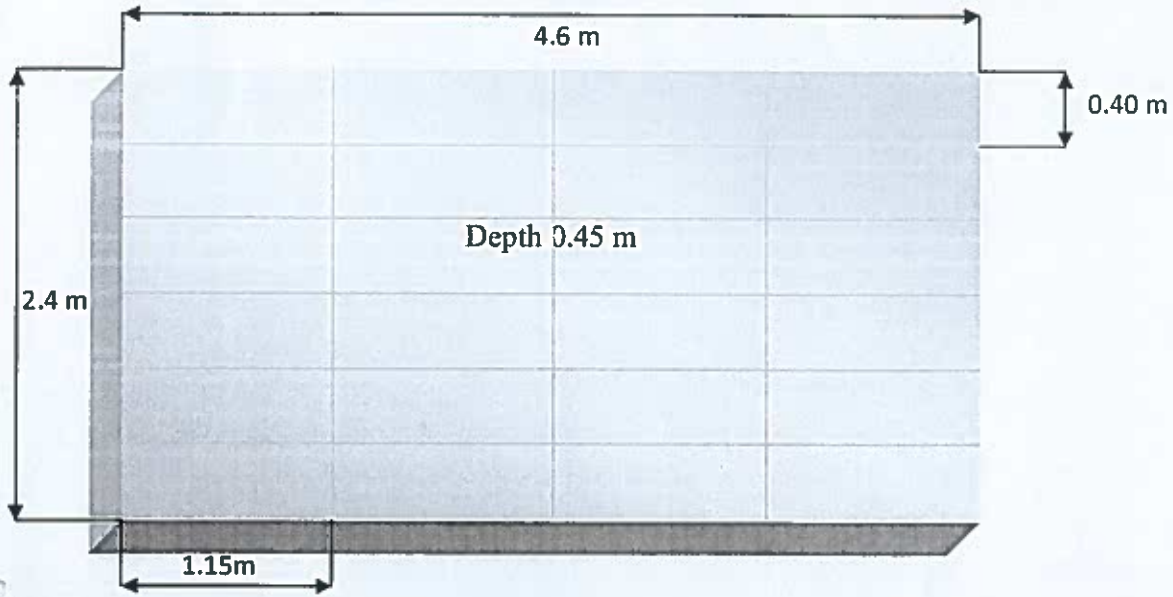

REFURBISHMENT OF TD (IFCS) OFFICE AT I FLOOR
CANTEEN BLDG, ADA HQ COMPLEX

LIST OF APPROVED MAKES

SI No.	Material	Approved Make
01.	Vitrified flooring tiles.	Khajaria / H & R Johnson / Naveen.
02.	Block boards of Termite / Water proof grade.	Archid Ply / Kit Ply / Anchor Board.
03.	Laminate.	Decolite / Decolm / Archid lam / green lam / Veerlam.
04.	Mineral fiber acoustic ceiling tiles.	Daiken / Amstrong / USG.
05.	Linear type modular work station.	Wipro / Godrej / Featherlite / HNR /Frontier.
06.	Roller blinds.	Vista / Fenesta / Hunter Douglas.
07.	Glass writing board.	Modi Guard glass / Saint Gobain / Assai glass.
08.	Hardware.	Should be branded item of ISI standard.
09.	Paint / Distemper.	Asian / Berger / ICI Ltd., Nerolac.
10.	PVC / CPVC Pipes.	Astral/Supreme/Ashirvad.
11.	CP Brass fitting.	Cera / Parryware/ Hindware.
12.	Floor / wall tiles.	Naveen/Khajaria/H&R Johnson.
13.	Vitreous European water closet / wash basin.	Cera / Parryware / Hindware.
14.	Mirror.	Konica / Modi.
15.	Doors and Frame.	Deccan Structure / Madhu industries.
16.	Cable / wire.	Finolex/Anchor/V-Guard /Havells /Polycab.
17.	Switch & Socket.	Anchor Roma / GM / WIPRO.
18.	Casing & Capping / Conduit.	Classic / Modi.
19.	Exhaust fan / Light fitting.	Bajaj / Usha / Crompton / Wipro / Philips.

